

Description

The DC1271P6 is an unidirectional TVS diode, utilizing leading monolithic silicon technology to provide fast response time and low ESD clamping voltage, making this device an ideal solution for protecting voltage sensitive data and power line. The DC1271P6 complies with the IEC 61000-4-2 (ESD) standard with $\pm 30\text{kV}$ air and $\pm 30\text{kV}$ contact discharge. It is assembled into an ultra-small 1.6x1.0x0.5mm lead-free DFN package. The small size and high ESD surge protection make DC1271P6 an ideal choice to protect cell phone, digital cameras, audio players and many other portable applications.

Mechanical Characteristics

- ◆ Package: DFN1610-2
- ◆ Case Material: "Green" Molding Compound.
- ◆ Moisture Sensitivity: Level 3 per J-STD-020
- ◆ Terminal Connections: See Diagram Below
- ◆ Marking Information: See Below

Dimensions and Pin Configuration

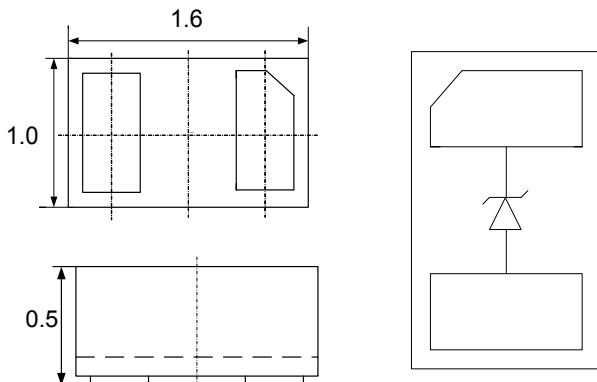

Package Dimensions (mm) Circuit and Pin Schematic

Features

- ◆ Small package: 1.6 x1.0 x0.5mm
- ◆ Protects one data or power line
- ◆ Operating voltage: 12V
- ◆ Ultra low leakage: nA level
- ◆ Low clamping voltage
- ◆ 2-pin leadless package
- ◆ Complies with following standards:
 - IEC 61000-4-2 (ESD) immunity test
 - Air discharge: $\pm 30\text{kV}$
 - Contact discharge: $\pm 30\text{kV}$
 - IEC 61000-4-5 (Lightning) 75A(8/20 μs)
- ◆ RoHS Compliant

Applications

- ◆ Mobile Phones
- ◆ Battery Protection
- ◆ Power Line Protection
- ◆ Vbat pin for Mobile Devices
- ◆ Hand Held Portable Applications

Marking Information

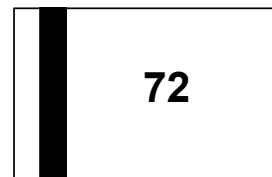

72 = Device Marking Code
Bar denotes Cathode

Ordering Information

Part Number	Marking	Packaging	Reel Size
DC1271P6	72	3000/Tape & Reel	7 inch

Absolute Maximum Ratings ($T_A=25^{\circ}\text{C}$ unless otherwise specified)

Parameter	Symbol	Value	Unit
Peak Pulse Power (8/20 μs)	Ppk	1875	W
Peak Pulse Current (8/20 μs)	Ipp	75	A
ESD per IEC 61000-4-2 (Air)	VESD	± 30	kV
ESD per IEC 61000-4-2 (Contact)		± 30	
Operating Temperature Range	TJ	-55 to +125	$^{\circ}\text{C}$
Storage Temperature Range	Tstg	-55 to +150	$^{\circ}\text{C}$

Electrical Characteristics ($T_A=25^{\circ}\text{C}$ unless otherwise specified)

Parameter	Symbol	Min	Typ	Max	Unit	Test Condition
Reverse Working Voltage	VRWM			12	V	
Breakdown Voltage	VBR	12.7			V	IT = 1mA
Reverse Leakage Current	IR			0.2	μA	VRWM = 12V
Forward Voltage	VF		1.0	1.2	V	IF = 10mA
Clamping Voltage	VC			18	V	I _{PP} = 10A (8 x 20 μs pulse)
Clamping Voltage	VC			25	V	I _{PP} = 75A (8 x 20 μs pulse)
Junction Capacitance	CJ			300	pF	VR = 0V, f = 1MHz

Typical Performance Characteristics (TA=25°C unless otherwise Specified)

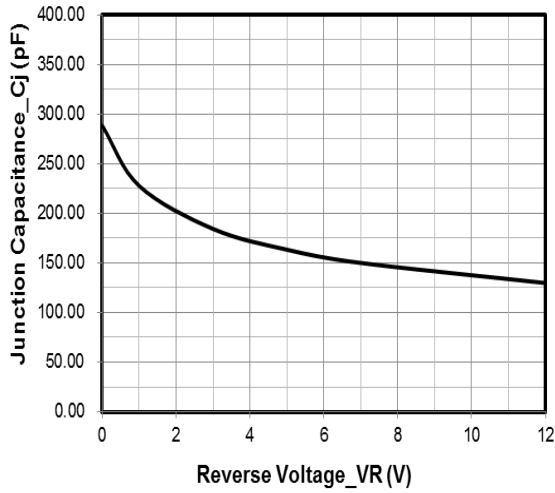

Junction Capacitance vs. Reverse Voltage

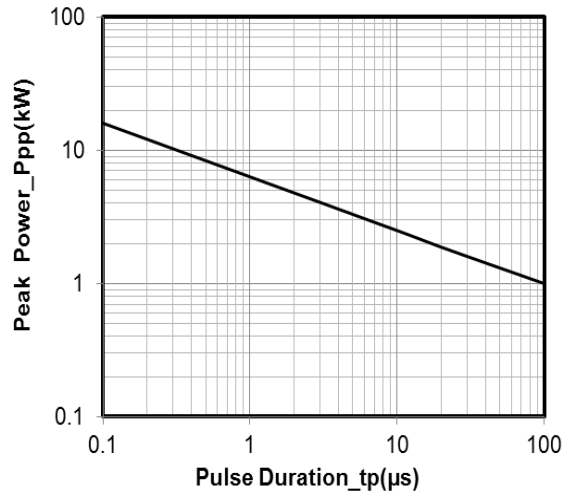

Peak Pulse Power vs. Pulse Time

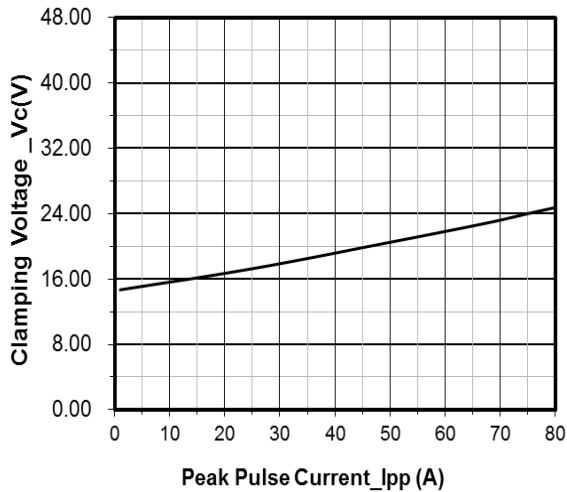

Clamping Voltage vs. Peak Pulse Current

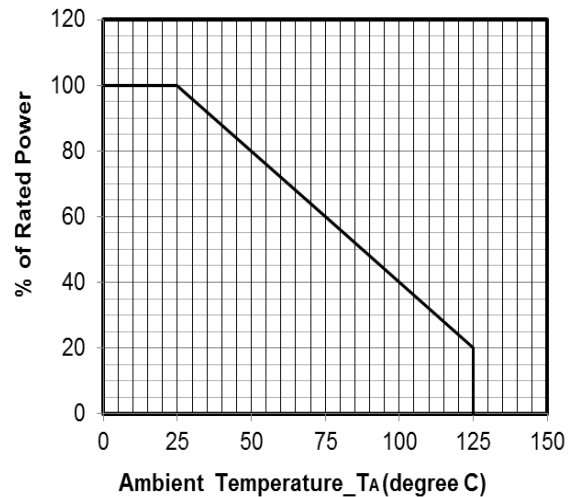

Power Derating Curve

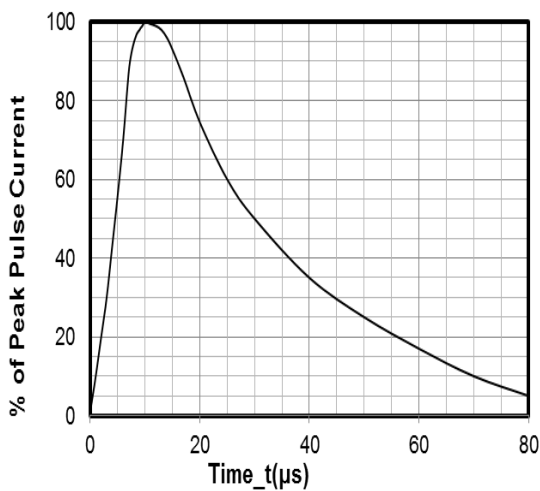

8 X 20μs Pulse Waveform

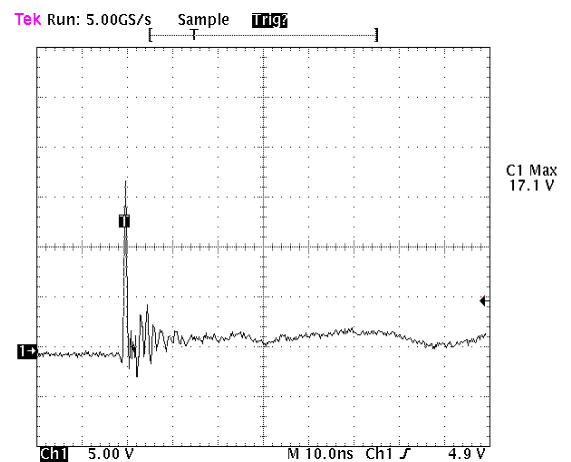

Note: Data is taken with a 10x attenuator

ESD Clamping Voltage

+8 kV Contact per IEC61000-4-2

